

Varenummer: 201581M630PLH1
 Beskrivelse: E+G Bolt GN 1582-M6-30-PL-H-1
 Hygiejnisk design

Mål

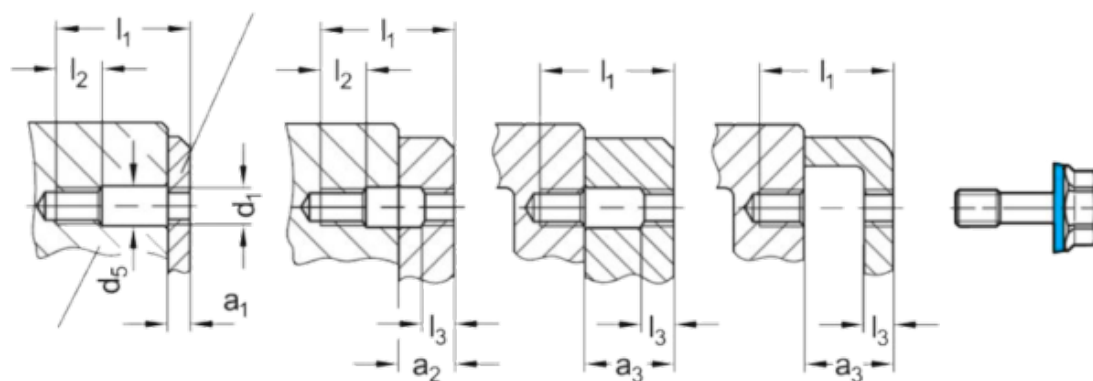
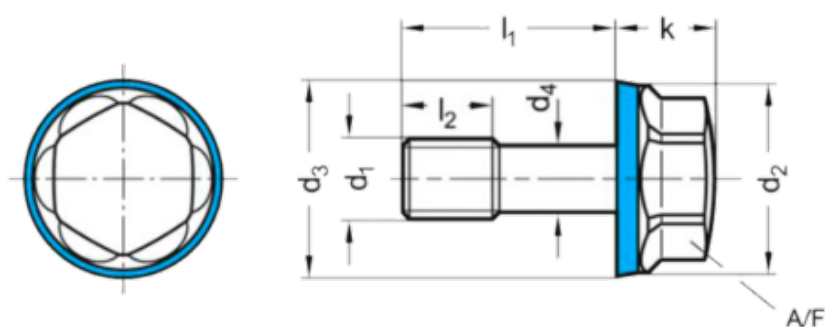

a1	= 7-12	l1	= 30
a2	= 12-17	l2	= 8
a3	= 17-22	l3	= 3
AF	= 10	Vægt	= 10
d3	= 13.8		
d4	-0,2 = -		
d5	= 6.5		
k	= 7.5		